

EXPLORE[®] SCIENTIFIC

6-inch/8-inch/10-inch Classic Dobsonians Instruction Manual

#ES-ON15476



#ES-ON20859



#ES-ON25447



x1
INCLUDED



WARNING:

SUN HAZARD – Never look directly at the sun with this device.
CHOKING HAZARD – Small parts. Not for children under 3 years.
The lens contains lead that may be harmful. Wash hands after touching.



CA WARNING:

This product can expose you to chemicals including lead, which is known to the State of California to cause cancer and birth defects or other reproductive harm. For more information go to www.P65Warnings.ca.gov.



WARNING:

This product contains a button battery. If swallowed, it could cause severe injury or death in just 2 hours. Seek medical attention immediately.

IMPORTANT SAFETY INSTRUCTIONS

READ AND FOLLOW THE INSTRUCTIONS BEFORE USE.
KEEP THESE INSTRUCTIONS FOR LATER USE.



• **SUN WARNING: WARNING – NEVER ATTEMPT TO OBSERVE THE SUN WITH THIS DEVICE! OBSERVING THE SUN – EVEN FOR A MOMENT – WILL CAUSE INSTANT AND IRREVERSIBLE DAMAGE TO YOUR EYE OR EVEN BLINDNESS.** EYE DAMAGE IS OFTEN PAINLESS, SO THERE IS NO WARNING TO THE OBSERVER THAT THE DAMAGE HAS OCCURRED UNTIL IT IS TOO LATE. DO NOT POINT THE DEVICE AT OR NEAR THE SUN. DO NOT LOOK THROUGH THE DEVICE AS IT IS MOVING. CHILDREN SHOULD ALWAYS HAVE ADULT SUPERVISION WHILE OBSERVING.

• **RESPECT PRIVACY:** WHEN USING THIS DEVICE, RESPECT THE PRIVACY OF OTHER PEOPLE. FOR EXAMPLE, DO NOT USE IT TO LOOK INTO PEOPLE'S HOMES.



• **CHOKING HAZARD:** CHILDREN SHOULD ONLY USE DEVICE UNDER ADULT SUPERVISION. KEEP PACKAGING MATERIALS LIKE PLASTIC BAGS AND RUBBER BANDS OUT OF THE REACH OF CHILDREN AS THESE MATERIALS POSE A CHOKING HAZARD.

• **RISK OF BLINDNESS:** NEVER USE THIS DEVICE TO LOOK DIRECTLY AT THE SUN OR IN THE DIRECT PROXIMITY OF THE SUN. DOING SO MAY RESULT IN A PERMANENT LOSS OF VISION.

• **RISK OF FIRE:** DO NOT PLACE DEVICE, PARTICULARLY THE LENSES, IN DIRECT SUNLIGHT. THE CONCENTRATION OF LIGHT RAYS COULD CAUSE A FIRE.

• **DO NOT DISASSEMBLE THIS DEVICE:** IN THE EVENT OF A DEFECT, PLEASE CONTACT YOUR DEALER. THE DEALER WILL CONTACT THE CUSTOMER SERVICE DEPARTMENT AND CAN SEND THE DEVICE IN TO BE REPAIRED IF NECESSARY.

• **DO NOT SUBJECT THE DEVICE TO TEMPERATURES EXCEEDING 60 °C (140 °F).**



• **DISPOSAL:** KEEP PACKAGING MATERIALS, LIKE PLASTIC BAGS AND RUBBER BANDS, AWAY FROM CHILDREN AS THEY POSE A RISK OF SUFFOCATION. DISPOSE OF PACKAGING MATERIALS AS LEGALLY REQUIRED. CONSULT THE LOCAL AUTHORITY ON THE MATTER IF NECESSARY AND RECYCLE MATERIALS WHEN POSSIBLE.



• THE WEEE SYMBOL IF PRESENT INDICATES THAT THIS ITEM CONTAINS ELECTRICAL OR ELECTRONIC COMPONENTS WHICH MUST BE COLLECTED AND DISPOSED OF SEPARATELY.

• NEVER DISPOSE OF ELECTRICAL OR ELECTRONIC WASTE IN GENERAL MUNICIPAL WASTE. COLLECT AND DISPOSE OF SUCH WASTE SEPARATELY.

• MAKE USE OF THE RETURN AND COLLECTION SYSTEMS AVAILABLE TO YOU, OR YOUR LOCAL RECYCLING PROGRAM. CONTACT YOUR LOCAL AUTHORITY OR PLACE OF PURCHASE TO FIND OUT WHAT SCHEMES ARE AVAILABLE.

• ELECTRICAL AND ELECTRONIC EQUIPMENT CONTAINS HAZARDOUS SUBSTANCES WHICH, WHEN DISPOSED OF INCORRECTLY, MAY LEAK INTO THE GROUND. THIS CAN CONTRIBUTE TO SOIL AND WATER POLLUTION WHICH IS HAZARDOUS TO HUMAN HEALTH, AND ENDANGER WILDLIFE.

• IT IS ESSENTIAL THAT CONSUMERS LOOK TO RE-USE OR RECYCLE ELECTRICAL OR ELECTRONIC WASTE TO AVOID IT GOING TO LANDFILL SITES OR INCINERATION WITHOUT TREATMENT.



BUTTON/COIN BATTERY WARNING: THIS PRODUCT CONTAINS A BUTTON OR COIN CELL BATTERY. A SWALLOWED BUTTON OR COIN CELL BATTERY CAN CAUSE INTERNAL CHEMICAL BURNS IN AS LITTLE AS TWO HOURS AND LEAD TO DEATH. DISPOSE OF USED BATTERIES IMMEDIATELY. KEEP NEW AND USED BATTERIES AWAY FROM CHILDREN. IF YOU THINK BATTERIES MIGHT HAVE BEEN SWALLOWED OR PLACED INSIDE ANY PART OF THE BODY, SEEK IMMEDIATE MEDICAL ATTENTION.

• A SWALLOWED BUTTON OR COIN CELL BATTERY CAN CAUSE INTERNAL CHEMICAL BURNS IN AS LITTLE AS TWO HOURS AND LEAD TO DEATH DUE TO CHEMICAL BURNS AND POTENTIAL PERFORATION OF THE ESOPHAGUS.

• DISPOSE OF USED BATTERIES IMMEDIATELY, FLAT/DRAINED BATTERIES CAN STILL BE DANGEROUS

• KEEP NEW AND USED BATTERIES AWAY FROM CHILDREN.

• IF YOU THINK BATTERIES MIGHT HAVE BEEN SWALLOWED OR PLACED INSIDE ANY PART OF THE BODY, SEEK IMMEDIATE MEDICAL ATTENTION.

• IF YOU SUSPECT YOUR CHILD HAS SWALLOWED OR INSERTED A BUTTON BATTERY IMMEDIATELY CALL THE POISONS CONTROL HOTLINE AND SEEK IMMEDIATE MEDICAL ATTENTION.

• EXAMINE DEVICES AND MAKE SURE THE BATTERY COMPARTMENT IS CORRECTLY SECURED, E.G. THAT THE SCREW OR ANOTHER MECHANICAL FASTENER IS TIGHTENED. DO NOT USE IF COMPARTMENT IS NOT SECURE.

• TELL OTHERS ABOUT THE RISK ASSOCIATED WITH BUTTON BATTERIES AND HOW TO KEEP THEIR CHILDREN SAFE.

Need Customer Support?

Our customer service experts will answer any question. Call us toll free **866.252.3811**.

Monday – Friday; 8am – 5pm Central Time

Or visit our online Customer Service Center at

www.explorescientific.supportsync.com

We know you'll enjoy your new Explore Scientific telescope for years to come.

Please familiarize yourself with the directions before beginning assembly.

As you know, the telescope arrives in two boxes: the smaller box contains the wooden parts and hardware for the Dobsonian base, and the larger box contains the telescope and accessories. We suggest you keep all boxes and packing materials in case you need to store, transport, or ship the telescope.

If you are new to amateur astronomy, we suggest learning the constellations that are visible in the night sky this time of year. Think of the constellations as states in a country, while the objects you want to observe are like counties and cities within them. While pointing the telescope is not hard, pointing it at a specific celestial target is a skill you need to learn. That comes from patience and practice.

It's also important to remember, because of light pollution around cities, the farther away you are from the city lights the more things you will see.

Table of Contents

1. Unpacking	pg. 4
2. Assembly	pg. 6
3. Installing the Red Dot Scope	pg. 11
4. Inserting an Eyepiece	pg. 12
5. Using Your Telescope	pg. 12
6. Tracking Objects	pg. 16
7. Collimating the Optics	pg. 17
8. Care and Maintenance	pg. 22
9. Telescope Basics	pg. 23
10. Specifications	pg. 30



WARNING:

DO NOT USE THIS TELESCOPE OR ANY ACCOMPANYING FINDER SCOPE TO LOOK AT OR NEAR THE SUN UNLESS YOU ARE USING A SPECIAL SOLAR FILTER! EVEN MOMENTARY VISUAL CONTACT WITH THE SUN'S LIGHT RAYS CAN INSTANTLY CAUSE IRREVERSIBLE DAMAGE TO YOUR EYE(S). EYE DAMAGE CAN BE PAINLESS, SO THERE IS NO WARNING TO THE OBSERVER THAT DAMAGE HAS OCCURRED UNTIL IT IS TOO LATE. TAKE EXTRA CARE WHEN USING THE TELESCOPE OR A FINDER SCOPE DURING DAYLIGHT HOURS, AND DO NOT POINT EITHER AT OR NEAR THE SUN. DO NOT LOOK THROUGH EITHER WHEN YOU ARE MOVING THE INSTRUMENTS DURING THE DAYTIME. NEVER ALLOW ANYONE TO USE THE TELESCOPE OR A FINDER SCOPE DURING THE DAYTIME WITHOUT WARNING THEM OF THE HAZARDS OF AIMING EITHER AT OR NEAR THE SUN. MAKE SURE THAT THEY ARE ADEQUATELY TRAINED ON THE USE OF THESE INSTRUMENTS BEFORE ALLOWING THEM TO START OBSERVING. CHILDREN SHOULD ALWAYS HAVE INFORMED AND TRAINED ADULT SUPERVISION WHILE OBSERVING.

1. Unpacking

Carefully remove all items from the boxes and spread the parts out on a flat surface.

Verify that you have all the parts listed in Figure 1.1 and Figure 1.2. If something is missing, double-check the shipping boxes. If the item still cannot be found, contact Explore Scientific Customer Service at 866.252.3811. Leave a detailed message including your name, address, phone number, and email address.

Parts List:

A – Front brace

B – Left & Right panels

C – Top baseplate (round)

D – Bottom baseplate (triangle)

E – Base assembly screw (x12)

F – Large hex-head bolt with washers, T-nut, lock nut

G – Phillips-head machine screw (x2)

H – Spring post (x4)

I – Bolt with rosette knob (x2)

J – Spring coil (x2)

K – Handle

L – Hex nut (x2)

M – Socket-head cap screw (x2)

N – Washer (x2)

O – Pull loops

P – Hex key (6mm)

Q – Hex key (4mm)

R – Hex key (2mm)

S – 14mm Crescent wrench

T – 17mm Crescent wrench (x2)

U – 25mm Plössl eyepiece, 1.25"

V – Red dot scope (with bracket)

W – Dust cover

X – Optical tube assembly

Y – Plastic bushing

Z – T-nut

AA – Bumper pad

BB – Screwdriver

CC – Smartphone Adapter

DD – Extension Tube

Figure 1.1

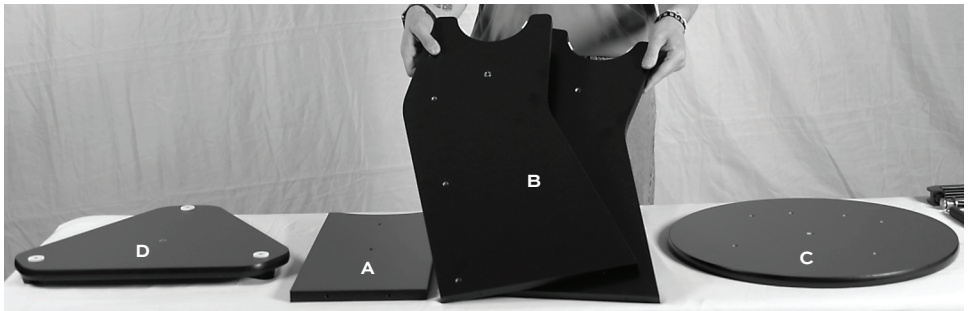
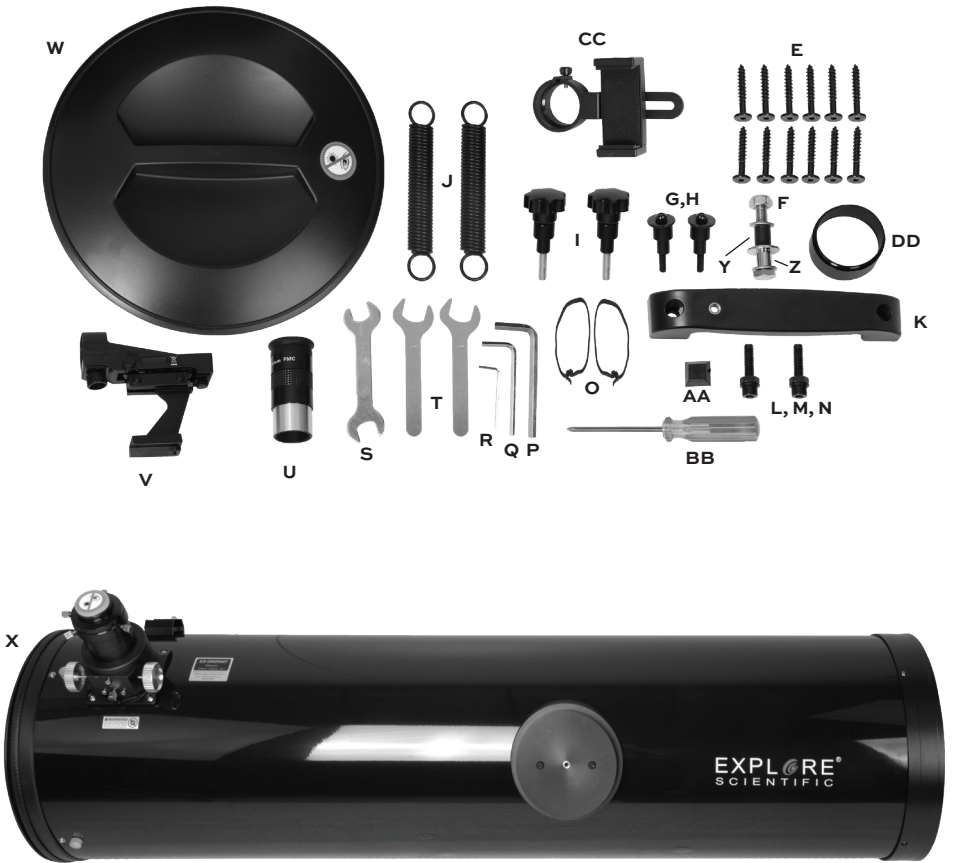

Figure 1.2



2. Assembly

The telescope tube itself comes fully assembled. All you need to do is install an eyepiece, focus it, and mount and align the red dot finderscope.

Assembly of the Dobsonian Base

Once assembled, the base does not need to be disassembled except for shipping or long-term storage. While assembling the base, refer to Figures 1.1 and 1.2. All required tools are included: Crescent wrenches, hex keys, and a Phillips screwdriver.

Examine the wooden panels. Two of them—the left and right sides—have silver flanged inserts pre-installed. **It is critical that these inserts face each other, not the outside of the base.** (See Figure 2.1)

Orient the front panel so that the felt pad at the bottom faces inward. Use six base assembly screws (Part E) to loosely attach the front brace (Part A) using the predrilled holes (Figure 2.2). Use the 4mm hex key (Part Q) to turn the screws, but do not fully tighten them yet.

Now turn the side panel assembly upside down and stand it upright as shown in Figure 2.3. Use six base assembly screws (Part E) to attach the top baseplate (Part C) through the predrilled holes. Tighten these screws.

Next, tighten the side-panel screws.

Locate the T-nut (Part Z) and place it in the center hole of the triangular bottom baseplate (Part D). Insert it from the side with the three white azimuth bearing pads (Figure 2.5).

As shown in Figure 2.4, insert the plastic bushing (Part Y) into the hole in the center of the top baseplate.

Thread the hex-head bolt (Part F), with a washer attached, up through the bottom baseplate from below (the side with the feet). Thread it into the T-nut until snug (Figure 2.5 shows the bolt before it has been fully threaded). Align the bolt with the center hole of the top baseplate and insert it through the hole. Place the remaining washer and lock nut onto the end of the bolt. You will only be able to turn the lock nut slightly by hand—just enough to get it started.

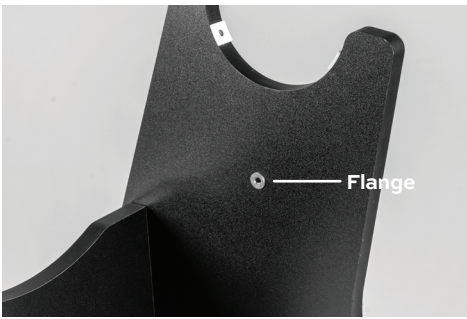

Figure 2.1

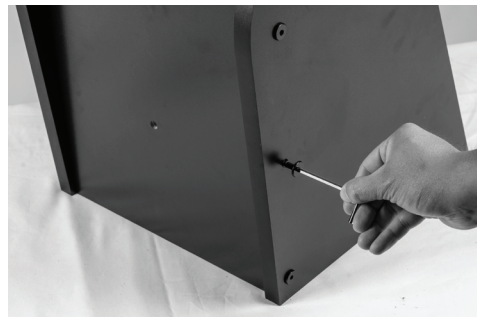

Figure 2.2



Figure 2.3

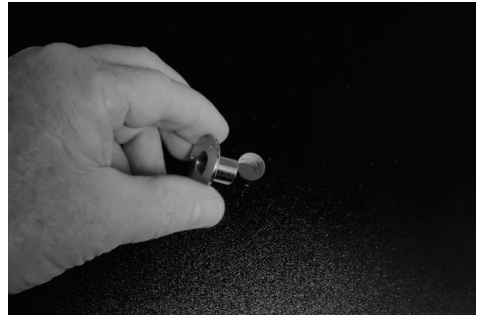

Figure 2.4

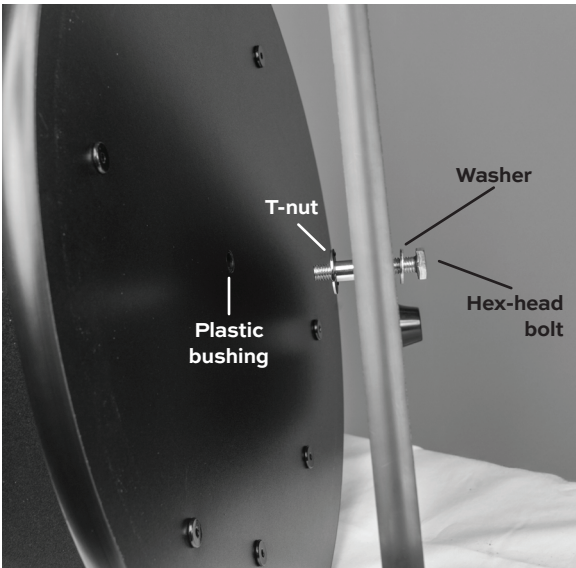

Figure 2.5

Using the two 17mm crescent wrenches (Part T), lightly tighten the two baseplates together. Place one wrench on the bolt head (under the bottom baseplate) and the other on the lock nut, as shown in Figure 2.6.

Tighten the lock nut just until the white plastic pads on the bottom baseplate make contact with the top baseplate. The bottom baseplate must be able to rotate freely; if the lock nut is overtightened, rotation will be difficult.

Test the rotation by standing the base upright on its feet and gently rotating it. If necessary, lay the base on its side and adjust the lock nut using the wrenches until smooth rotation is achieved.



Figure 2.6

Attach the handle (Part K) to the front brace with the two socket-head cap screws (Part M). Insert the screws through the handle and into the predrilled holes of the front panel (Figure 2.7). Place a washer (Part N) on each protruding screw end, then thread on a hex nut (Part L) as shown in Figure 2.8. Tighten the nut using the provided 14mm crescent wrench (Part S) while holding the bolt stationary with the 6mm hex key (Part P).



Figure 2.7

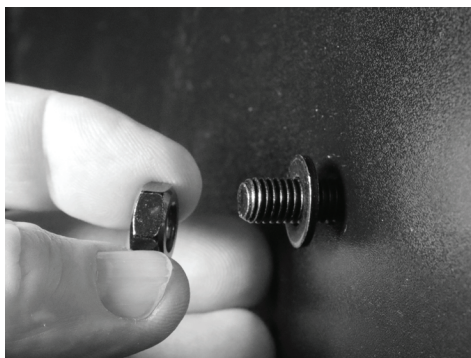

Figure 2.8

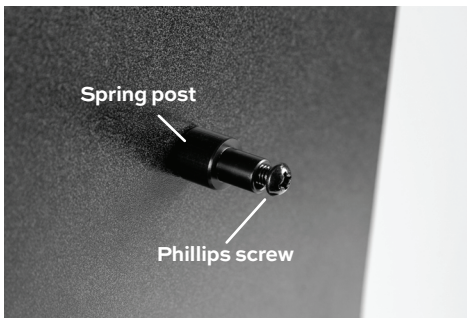

Figure 2.9

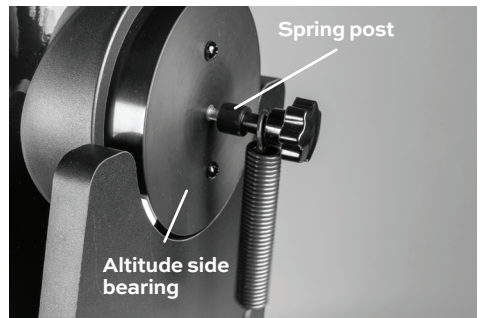

Figure 2.10

On each side panel of the base, install a plastic spring post (Part H) as shown in Figure 2.9. Thread the Phillips-head screw (Part G) into the threaded metal insert in the hole and tighten. Ensure that the thicker part of the post is positioned closest to the side panel, as illustrated.

Insert one of the long bolts with a rosette knob (Part I) through the end ring of one spring coil (Part J). Slip a spring post onto the screw. Orient the spring post so that the narrow end is closest to the knob. Thread the assembly into the hole at the center of one of the telescope's altitude side bearings until tight (Figure 2.10). The end ring of the spring should rest on the narrow part of the spacer. Repeat this procedure for the other altitude side bearing.

Lift the optical tube (Part X) and rest the altitude bearings on either side of the tube into the cradles of the side panels (Figure 2.11).



Figure 2.11



Figure 2.12

Attach a pull loop (Part O) onto the free end of each spring (Figure 2.12).

Thread the opposite end of the pull loop through the loop itself, as shown in Figure 2.13, and pull it taut (Figure 2.14).



Figure 2.13



Figure 2.14

Pull each spring downward using the pull loop, positioning the spring's end ring over the head of the Phillips screw and onto the narrow part of the spring post (Figure 2.15).

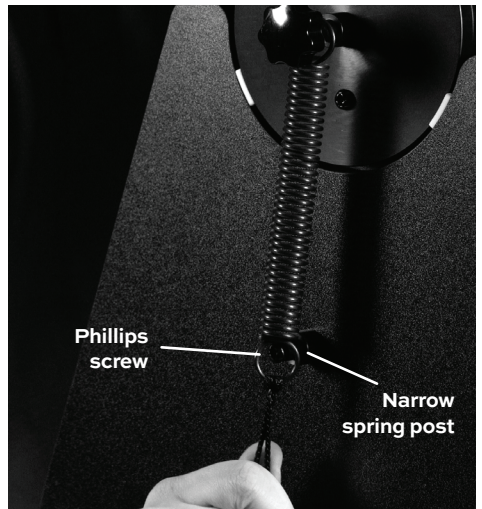

Figure 2.15

Now apply the adhesive bumper pad (Part AA) to the inside surface of the front brace, at the point where the bottom end ring of the optical tube contacts the front brace when the tube is rotated just past vertical (Figure 2.16). Peel the backing from the bumper pad to expose the adhesive.

The telescope is now mounted on the base and the spring system is engaged. To remove the telescope from the base, unhook the springs from the spring posts on the Dobsonian base. The springs remain attached to the altitude side bearings, so they will not be lost.

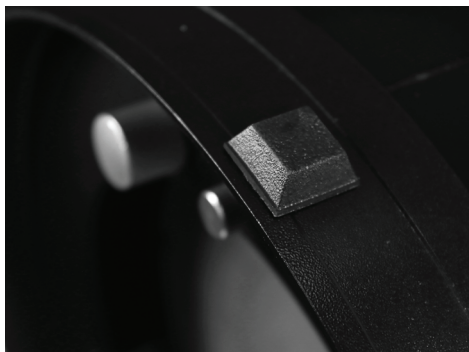

Figure 2.16

3. Installing the Red Dot Scope

To install the red dot scope, slide its dovetail mounting bracket into the telescope's dovetail base. Tighten the thumbscrew on the base to secure the mounting bracket (Figure 3.1). Remove and discard the plastic tab sticking out of the battery compartment. This allows the red dot scope's circuit to receive power from the installed 3V battery.

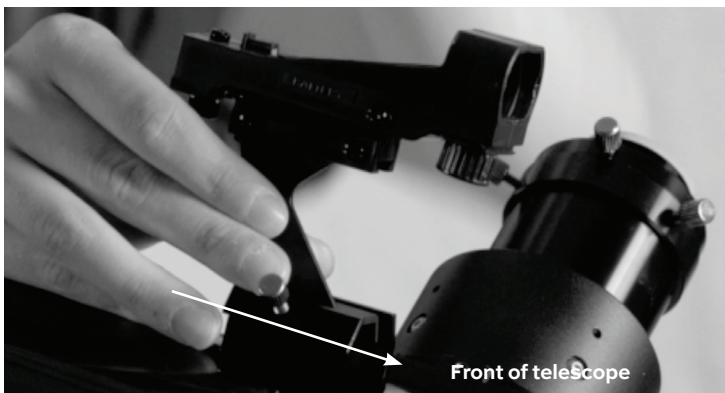

Figure 3.1



WARNING:

- **INGESTION HAZARD** — This product contains a button cell or coin battery.
- **DEATH** or serious injury can occur if ingested.
- A swallowed button cell or coin battery can cause **Internal Chemical Burns** in as little as 2 hours.
- **KEEP** new and used batteries **OUT OF REACH OF CHILDREN**.
- **Seek immediate medical attention** if a battery is suspected to be swallowed or inserted inside any part of the body.

4. Inserting an Eyepiece

The final step in assembly is to insert an eyepiece into the focuser. Remove the dust cap from the focuser drawtube. To insert the included 1.25" eyepiece (Part U), loosen the thumbscrew on the 1.25" adapter. Insert the eyepiece into the adapter, then gently retighten the thumbscrew to secure it.

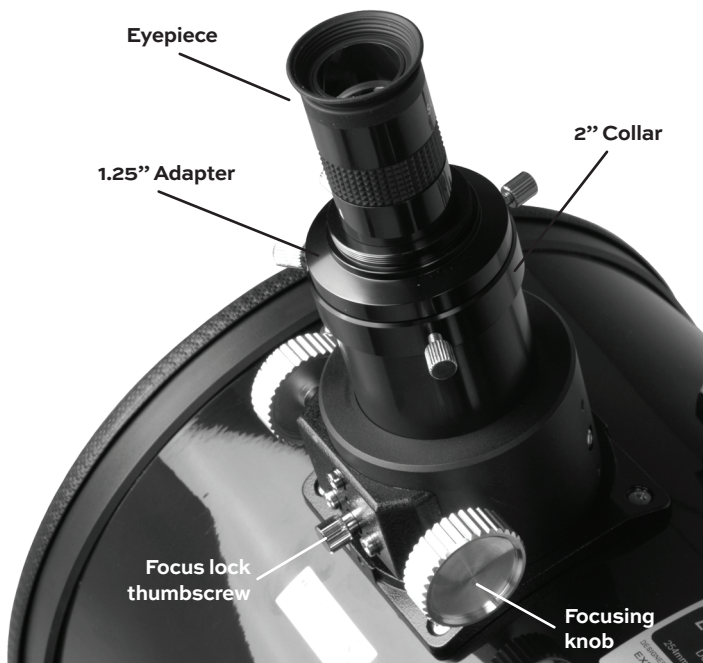

Figure 4.1

5. Using Your Telescope

You are now ready to take your telescope outside and begin exploring the night sky.

If you are new to amateur astronomy, start by observing bright, easily found objects such as the Moon or the planet Saturn. These will help you learn how to point, focus, and track objects before moving on to fainter targets.



Figure 5.1

Azimuth

Moving the Telescope

The telescope is designed to move smoothly in two directions:

- Altitude – up and down (vertical movement)
- Azimuth – left and right (horizontal movement)

Grasp the telescope gently near the front of the tube and move it in the desired direction. The base and spring-tension system allow the tube to move smoothly while staying in place when released.

Aligning the Red Dot Finder

The finder must be aligned with the main telescope before it can be used effectively.

1. Choose a distant object, such as the top of a telephone pole, a treetop, or a streetlight. In daylight, a faraway object works best. At night, use the Moon.
2. Center the object in the telescope's eyepiece. Use the lowest-power eyepiece (the one with the largest number, e.g., 25mm) for the widest field of view.
3. Without moving the telescope, look through the red dot finder. Use the two adjustment screws on the finder to move the red dot until it is centered on the same object.
4. Verify alignment by choosing another distant object and checking that it also lines up in both the finder and the eyepiece.

Once aligned, the finder will remain accurate unless it is bumped or removed. If that happens, simply realign it using the same procedure.

Using the Red Dot Finder

The red dot finder helps you aim the telescope. Unlike a magnifying finderscope, it projects a small illuminated dot onto a clear glass window, showing you where the telescope is pointed.

1. Turn on the red dot finder by sliding the power switch forward.
2. Look through the finder with both eyes open. A red dot will appear on the window.
3. Move the telescope until the dot is centered on the object you want to observe.
4. Turn off the finder after use to conserve battery life.

Focusing the Telescope

To focus:

1. Insert an eyepiece into the focuser and secure it with the thumbscrew.
2. Look through the eyepiece at a bright object.
3. Slowly turn the focuser knobs until the object appears sharp and clear.

Switching to a higher-power eyepiece (a smaller number, e.g., 10mm) will make objects appear larger, but the field of view will be narrower and tracking will require more frequent adjustment. Always start with the lowest-power eyepiece before moving to higher power.

Determining Magnification

The word magnification describes how much closer a telescope makes an object appear.

There are two parts to calculating magnification: focal length of the telescope and focal length of the eyepiece (the number on the side of the eyepiece).

To calculate magnification, divide the focal length of the telescope by the focal length of the eyepiece.

$$\frac{\text{Telescope Focal Length}}{\text{Eyepiece Focal Length}} = \text{Magnification}$$

For example, the 6-inch Dobsonian telescope has a focal length of 1170 mm. Using the 25 mm eyepiece, the math is:

$$\frac{1170 \text{ mm}}{25 \text{ mm}} = 46.8x$$

/ / \

Telescope Eyepiece Magnification
Focal Length Focal Length

That means what you're looking at is magnified 47 times – called 47x. If you use an eyepiece of a different focal length, simply remember the formula: telescope focal length divided by the number on the side of the eyepiece.

Eyepieces can be purchased that have a shorter focal length, which means it will offer more magnification. Many beginning telescope users think that high power is where it's at: Sometimes, that's true.

But that high power creates some tough situations.

1. The object gets dimmer
2. Focusing becomes more of a challenge
3. Keeping the target in the eyepiece is hard because not only have you highly magnified the size, you have magnified the speed it moves by the same amount. So, you're going to have to move your telescope more often.
4. You will magnify the seeing conditions in the air between you and space. If the stars are twinkling, then that's going to impact how the moon, planets, galaxies and all the other heavenly wonders look.

That's why you should start your evening's observing using the eyepiece with the lower magnification (the biggest number on the side). Why? Because at low power you have a better chance of getting an object in the eyepiece and centered.

If you start out at a high power, the chance of finding your target in the eyepiece is slim. Once centered, go to the next lower focal length eyepiece and center it again. You can keep doing this until you reach a point that the viewing is not good.

Limits of Magnification

Each telescope system has a theoretical limit to its magnification power. A good rule of thumb is a telescope's useful magnification is 2 times the aperture in millimeters. The 6-inch Dobsonian telescope is 154 mm in diameter, meaning the maximum magnification is going to be 308x.

$$\frac{\text{Telescope Focal Length}}{\text{Telescope Diameter (x2)}} = \text{Max. Eyepiece Focal Length}$$

What eyepiece would give that magnification? Here's the math: Focal length of the telescope divided by 308.

$$\frac{1170 \text{ mm}}{308} = 3.8 \text{ mm}$$

/ / \

Telescope Telescope Max. Eyepiece
Focal Length Diameter(x2) Focal Length

You need an eyepiece with a focal length of 3.8 mm. Trust us when we say that is pushing things to the limit. Unless you have absolutely perfectly stable, clear conditions and a sky free from light pollution, achieving that magnification is not going to happen. Under typical skies, the object is going to be blurry, dim, and jumping around – and zipping out of the eyepiece in mere seconds.

Low to medium powers – like those offered by the eyepiece that came with your telescope – offer the most pleasurable experience.

6. Tracking Objects

Because the Earth rotates, celestial objects appear to drift across the sky. To keep an object in view, gently nudge the telescope in the same direction as its movement. The smooth bearings of the Dobsonian base make this easy, but high magnification will require more frequent adjustments.

Observing Tips

1. Allow the telescope to cool down outdoors for 20–30 minutes before observing. This helps the optics reach thermal equilibrium, improving image sharpness.
2. Observe from the darkest location available. Even moving a few blocks away from streetlights can improve what you see.
3. Avoid observing bright objects (like the Moon) immediately before looking for faint deep-sky objects, as your eyes will take time to adjust to the dark again.
4. Use a red flashlight when reading charts or notes, since red light preserves your night vision.

7. Collimating the Optics

All Newtonian telescopes have two mirrors: A primary mirror (the big one) and a secondary mirror.

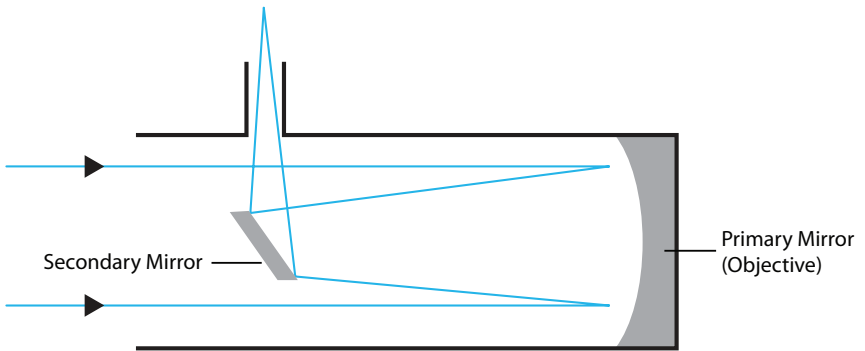
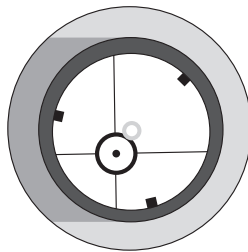
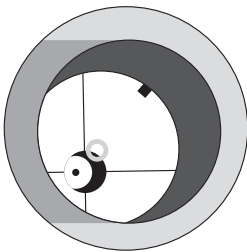

Figure 7.1

The primary mirror on your telescope is center marked with a small ring. Why? This center mark offers a way to get very precise collimation if you are using an optional collimation tool – like a laser collimator. Don't worry about the ring being visible when you look through an eyepiece – the ring is hidden by the secondary mirror.

Although the optics in your telescope were collimated in the factory, they may have moved during shipment. The procedure is straightforward and should take only a few minutes – once you learn it. We find it easiest to work on collimation in a brightly lit room. This is especially true when you are learning how to do it. Collimation is done in three steps.

Out of collimation examples.



Collimated example.

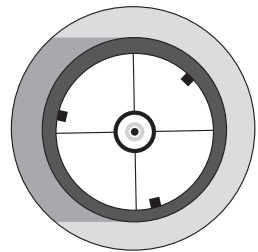

Rough Collimation

Collimating the secondary mirror (Figure 7.1): If the telescope is collimated you should see the concentric images of your eye, reflections of the secondary mirror and primary mirror, primary mirror center mark and the focuser (Figure 7.2). If the telescope does not look like Figure 7.2 or looks like one of the out of collimation examples below, continue on to the next steps.

- 1: Draw tube barrel
- 2: Primary mirror reflection
- 3: 4 vanes of secondary mirror holder
- 4: Secondary mirror reflection
- 5: Your eye
6. Primary mirror center ring mark

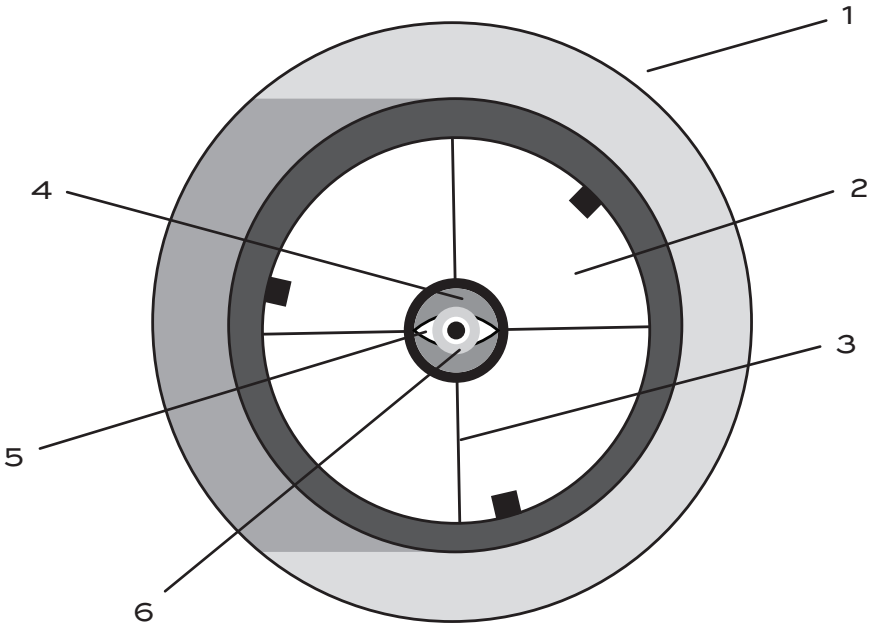
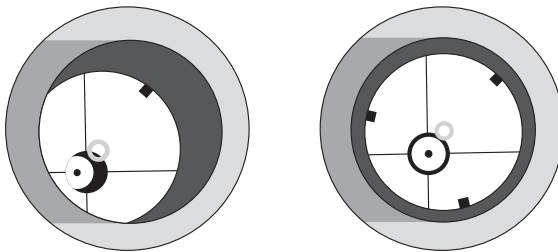

Figure 7.2



Out of collimation examples.

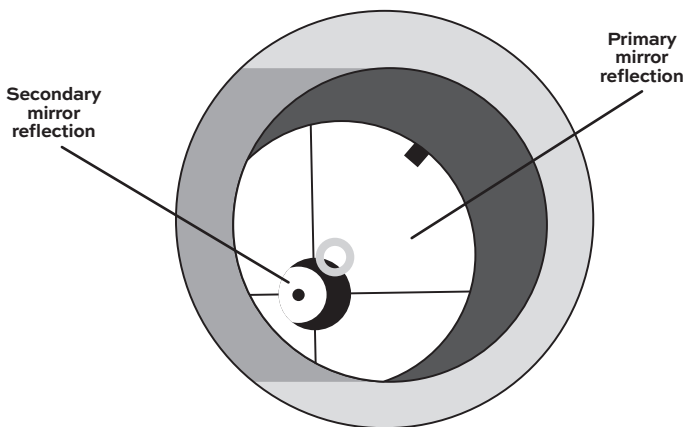

Figure 7.3

Remove the eyepiece from the focuser and, from about a foot away, and with one eye, look through the focuser draw tube. The secondary mirror reflection (your eye) needs to appear round. If the secondary mirror reflection does not appear round (Figure 7.3), tilt it with the three collimation screws (Figure 7.4) that are located on the sky side of the secondary mirror holder.

Do this by first loosening one of the secondary mirror's collimation screws, then tighten the other two. **ALWAYS** loosen one, then tighten at least one if not two. Use a Phillips screwdriver for this task.

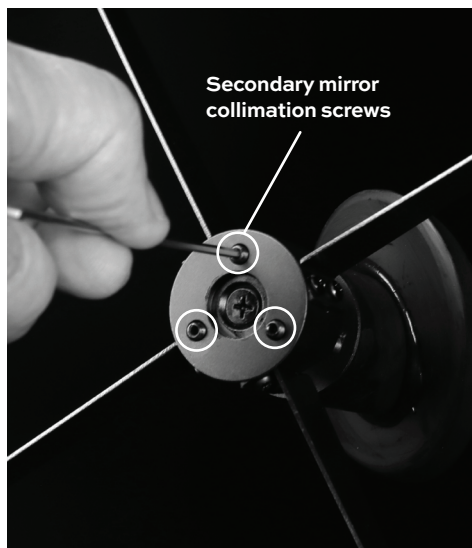

Figure 7.4

IMPORTANT: Turn these screws by very small amounts: No more than 1/8th of turn.

If you see that the secondary mirror reflection appears off center from the primary mirror reflection (Figure 7.5), this will be corrected further in the process. This process can only be accomplished by trial and error. If your first effort to adjust the secondary makes it move in the wrong direction, simply loosen another screw and determine the effect it has. Soon you'll be moving it into the correct position.

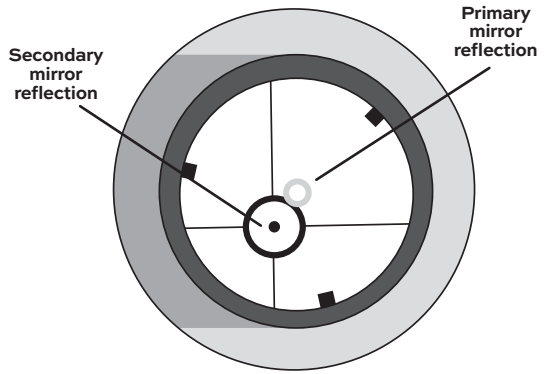

Figure 7.5

Once the image is round, be sure all the screws are tight.

Adjusting the primary mirror

The goal is to line up the ring mark with the secondary mirror, as shown in Figure 7.2.

Adjust the tilt of the primary mirror by using the three spring-loaded knobs on the bottom end of the telescope (Figure 7.6). Next to the spring-loaded knobs are three small thumbscrews that serve as locks. First loosen the thumbscrews by no more than 2 turns.

While looking through the focuser draw tube, turn one of the spring-loaded knobs about $\frac{1}{4}$ of a turn and observe what happened.

Figure 7.6



If it moved closer, slowly turn it. Chances are you are going to have to tighten, or loosen, all three screws to get the mirror tilted correctly. This will require trial and error – and patience.

Once you have it centered, gently tighten the thumbscrews. **DO NOT** overtighten them. Remember, the goal is to get the reflection of the secondary mirror centered on the primary mirror.

Do not have a quest for perfection! Close enough is good enough, especially for an inexperienced person. Get it close, then get out under the stars. Your skills will improve and you'll be able to get better collimation.

You can achieve precise collimation, but it requires use of optical collimation tools, including a laser collimator, a Cheshire eyepiece, or a collimation cap. Note that if you handle the telescope roughly, you are going to knock it out of collimation. Treat it gently.

Fine Collimation

For fine collimation, it is important that the telescope has cooled down to ambient air temperature. This is because heat exchange from the primary mirror to the air outside goes up the tube. Just like heat rising off hot pavement creates waves that look like mirages, the heat traveling up can cause distortion.

During fine collimation, locate Polaris and view it with high magnification. If the telescope is collimated well, you will see a system of dim rings of light surrounding a central bright spot — the airy disc. You will also notice a dim cross of light coming from this airy disc. This is the diffraction that is caused by the vanes that hold the secondary mirror in place. We have left this cross out of the next figures for clarity. What we want to see is shown in Figure 7.9 – a central airy disc that is surrounded by concentric rings. However, it is much more likely that the picture will be different – more like Figure 7.7. It is essential that you always center the star because outside of the optical axis all stars do show some distorted images. Note: You will get those images only during moments of perfect steady air because air turbulence will distort this image; however, the collimation goal remains the same – getting a concentric star image. So let us assume you have good seeing and your eyepiece shows you something like Figure 7.7.

Try turning the main mirror spring-loaded collimation knobs (after loosening the Phillips screw locks). When you are turning the correct screw in the proper direction, you will notice that the distracting “tail” is getting shorter. (Figure 7.8)



Figure 7.7

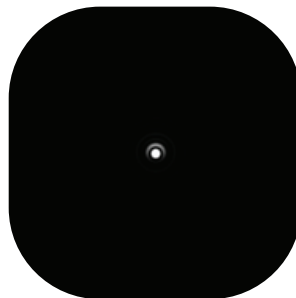

Figure 7.8

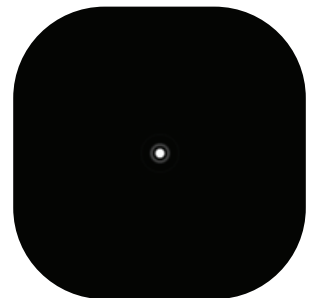

Figure 7.9

Remember to recenter the star after you have turned a screw. When the telescope is perfectly aligned, you will see the picture of Figure 7.9 (when the air is perfect). While using your telescope you will get a feel for this – it does not make sense to spend a lot of time on collimation when the air is moving too much.

Important: Outside the optical axis (the middle of the field of view) all stars will be distorted and show tails directed to the edge of the field of view. If you are using cheap eyepieces those star images will be even more distorted because the off-axis aberrations of the telescope and the eyepiece will add up. For this reason, it is essential to recenter Polaris after every turn of a collimation screw because the turning of the screw will also shift the star from its centered position. As mentioned before, it may not be possible to get a sharp star image during periods of turbulent air. In this case try to achieve a symmetrical image during collimation. If you don't see any more improvement, abort the process. During nights of unsteady seeing, it is not recommended to use high magnification. Try to enjoy low magnification objects like nebulae, clusters and galaxies on those nights instead of fretting over the bad conditions.

8. Care and Maintenance

It will not be long before you can see dust on the primary mirror – especially if you use a bright flashlight. The bright flashlight makes the dust look MUCH worse than it is. It takes a lot of dust on a mirror for it to need cleaning. If you look down the tube and can see your reflection in normal room light, it does not need cleaning.

If you believe your telescope primary mirror needs cleaning, contact Customer Support (866.252.3811) for assistance.

9. Telescope Basics

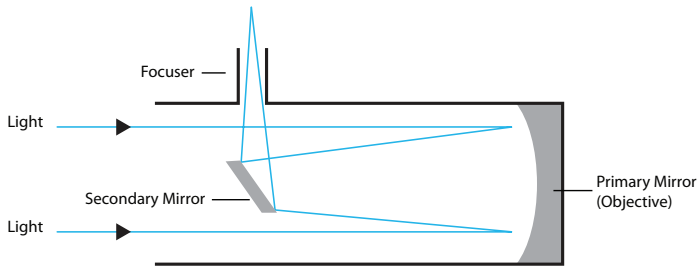

Types Of Telescopes:

Reflector

A reflector telescope uses mirrors to gather and focus light. Light enters the telescope through its open front end and travels to the concave primary mirror at the back. From there the light is reflected back up the tube to a flat secondary mirror, which sits at a 45° angle in relation to the eyepiece. Light bounces off of this secondary mirror and out through the eyepiece. A reflector telescope is designed for astronomical use. Terrestrial objects may appear inverted, sideways or at an angle depending on how your tube is oriented due to optical design. This rotation is perfectly normal on all Newtonian reflectors and will not affect astronomical viewing.

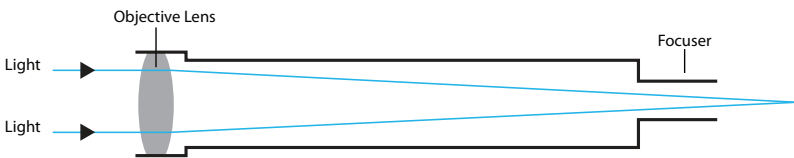

Refractor:

A refracting telescope uses a collection of lenses to gather and focus light. A refractor's views will be upside down if a diagonal is not in use. A standard diagonal will generate a "right side up" image, however, it will rotate the image on the vertical axis (mirror image). To get the "right side up" image without the rotation, you will need to use a special diagonal with an erect image prism.

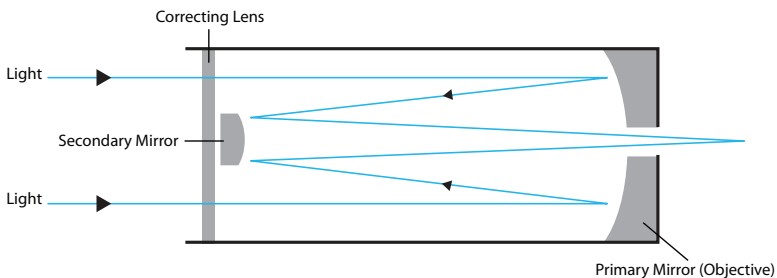

Catadioptric:

A catadioptric telescope uses a combination of mirrors and lenses to gather and focus light. Popular catadioptric designs include the Maksutov-Cassegrain and Schmidt-Cassegrain.

Refractor Telescope

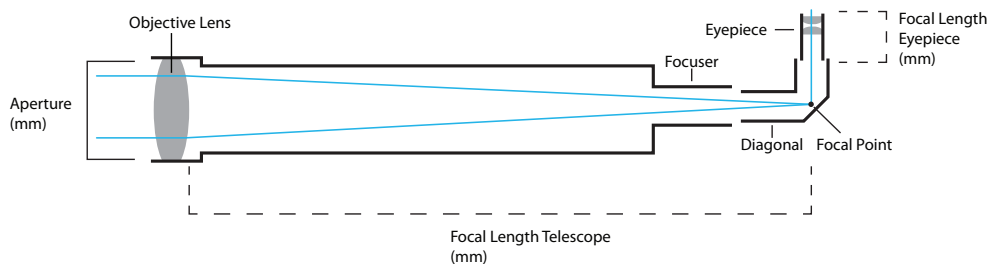

Telescope Terms to Know:

Aperture:

This figure, which is usually expressed in millimeters, is the diameter of a telescope's light-gathering surface (objective lens in a refractor or primary mirror in a reflector). Aperture is the key factor in determining the brightness and sharpness of the image.

Objective Lens:

The objective lens is the main light-gathering component of a refractor telescope. It is actually composed of several lens elements.

Diagonal:

This accessory houses a mirror that deflects the ray of light 90 degrees. With a horizontal telescope tube, this device deflects the light upwards so that you can comfortably observe by looking downwards into the eyepiece. The image in a standard diagonal mirror appears upright, but rotated around its vertical axis (mirror image). To get an image without this rotation, you will need to use a special diagonal with an erect image prism.

Eyepiece:

An eyepiece is an optical accessory comprised of several lens elements. It determines the magnification of a particular observing setup.

Primary Mirror:

The primary mirror is the principle light-gathering surface of a reflector telescope.

Secondary Mirror:

A secondary mirror is a small mirror that sits at a 45° angle in relation to the primary mirror of a reflecting telescope. Light from the primary mirror is reflected back up the tube to the secondary mirror. The light is directed from this mirror up into the eyepiece.

Reflector Telescope

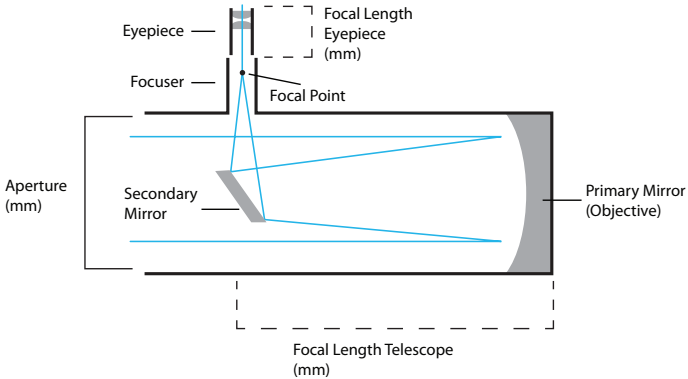

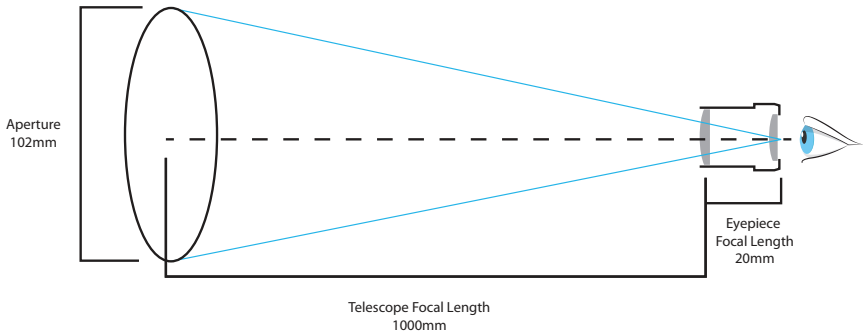

Magnification:

The magnification corresponds to the difference between observation with the naked eye and observation through a magnifying device like a telescope. If a telescope configuration has a magnification of 30x, then an object viewed through the telescope will appear 30 times larger than it would with the naked eye. To calculate the magnification of your telescope setup, divide the focal length of the telescope tube by the focal length of the eyepiece. For example, a 20mm eyepiece in a telescope with a 1000mm focal length will result in 50x power, which will make the object appear 50 times larger. If you change the eyepiece, the power goes up or down accordingly.

$$\text{Focal Ratio} = \frac{\text{Telescope Focal Length}}{\text{Telescope Aperture}}$$

Focal ratio

The focal ratio of a telescope is determined by dividing the telescope's focal length by its aperture (usually expressed in millimeters). It plays a key role in determining a telescope's field of view and significantly impacts imaging time in astrophotography. For example, a telescope with a focal length of 1000mm and a 100mm clear aperture has a focal ratio of f/10.

$$\text{Magnification} = \frac{\text{Telescope Focal Length}}{\text{Eyepiece Focal Length}}$$

Focal length (Telescope):

The focal length is the distance in millimeters between the objective lens or primary mirror and the point at which entering light rays converge — otherwise known as the focal point. The focal lengths of the telescope tube and the eyepiece are used to determine magnification.

Focal length (Eyepiece):

The focal length is the distance in millimeters between the center of the first lens element in an eyepiece and the focal point. The focal lengths of the telescope tube and the eyepiece are used to determine magnification. Short eyepiece focal lengths produce higher magnifications than long eyepiece focal lengths.

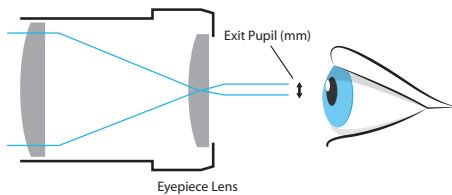

$$\text{Exit Pupil} = \frac{\text{Eyepiece Focal Length}}{\text{Telescope Focal Ratio}}$$

Exit Pupil

The exit pupil is the diameter of the beam of light coming out of the eyepiece. To calculate exit pupil, divide the focal length of your eyepiece by your telescope's focal ratio. For example, if you use a 20mm eyepiece with an f/5 telescope, the exit pupil would be 4mm.

Eye Relief

Eye relief is all about a comfortable viewing experience because it is the distance at which you need to position your eye from the eyepiece's outermost surface to enjoy the full field of view. This characteristic is of special concern to observers who wear glasses to correct an astigmatism, because a long enough eye relief is necessary to allow room for glasses.

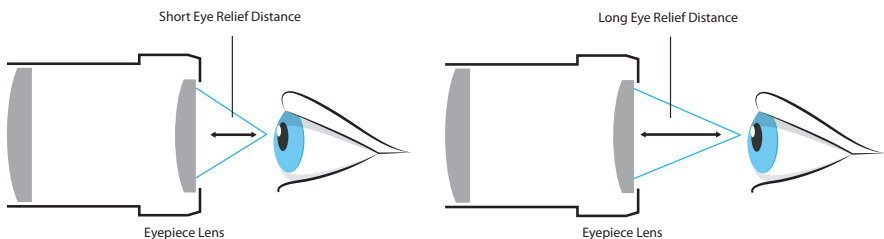

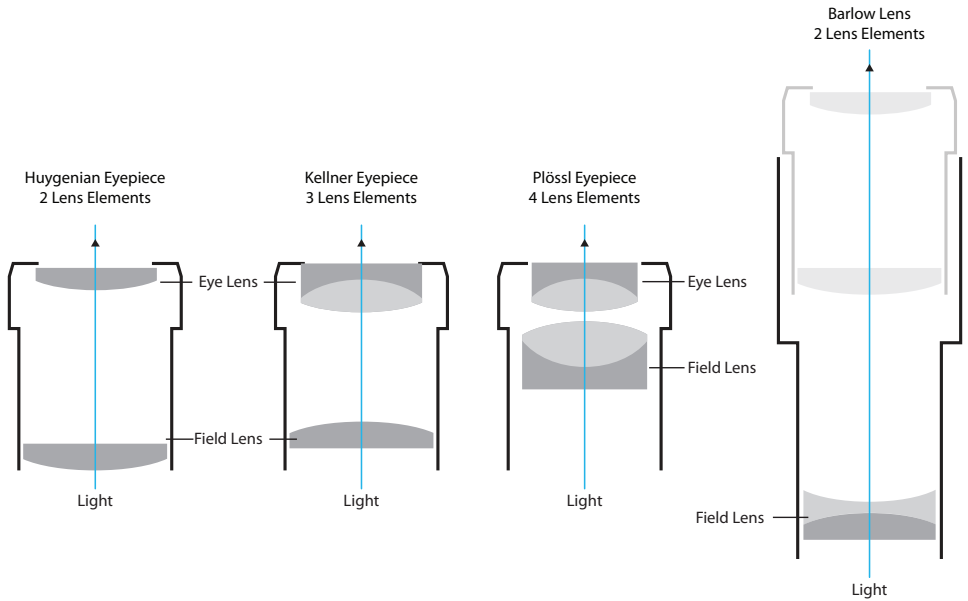

Huygenian Eyepieces:

A Huygenian eyepiece uses two plano-convex lenses separated by an air gap. They have a fairly narrow apparent field of view.

Kellner Eyepieces:

A Kellner eyepiece uses three lens elements - two of which are paired together in an achromatic doublet design to minimize chromatic aberrations. They typically produce an apparent field of view around 45° .

Plössl Eyepieces:

A Plossl eyepiece uses two doublets (a pairing of lens) for a total of four lens elements. This eyepiece design delivers sharp views and an apparent field of view of approximately 50° , which works well for both planetary and deep sky viewing.

Barlow Lens:

A Barlow lens effectively increases the focal length of a telescope. It is inserted between the eyepiece and the focuser/diagonal (depending on the optical setup) and multiplies the magnification power of the eyepiece. For example, a 2x Barlow will double the magnification of a particular eyepiece.

10. Specifications

ES-ON15476 - 6" Classic Dobsonian

Focal Length:	1170mm
Aperture:	154mm
Focal Ratio:	f/7.6
Focuser:	2" Crayford, with 1.25" adapter
Optical Tube Material:	Rolled steel
Mirror Figure:	Paraboloid
Mirror Coatings:	90% reflectivity, with SiO ₂ overcoat
Minor Axis of Secondary Mirror:	37.5mm
Eyepiece:	1.25" 25mm Plossl
Magnification with Supplied Eyepiece:	47x
Finderscope:	Red Dot
Base Handle:	Yes
Eyepiece Height at Zenith:	44.5"
Optical Tube Weight:	11 lbs., 14.3 oz.
Base Weight:	19 lbs., 6 oz.
Tube Length:	44.1"
Tube Outer Diameter:	7.3"

ES-ON20859 - 8" Classic Dobsonian

Focal Length:	1219mm
Aperture:	208mm
Focal Ratio:	f/5.9
Focuser:	2" Crayford, with 1.25" adapter
Optical Tube Material:	Rolled steel
Mirror Figure:	Paraboloid
Mirror Coatings:	90% reflectivity, with SiO ₂ overcoat
Minor Axis of Secondary Mirror:	46mm
Eyepiece:	1.25" 25mm Plossl
Magnification with Supplied Eyepiece:	49x
Finderscope:	Red Dot
Base Handle:	Yes
Eyepiece Height at Zenith:	44.5"
Optical Tube Weight:	19 lbs., 15.6 oz.
Base Weight:	18 lbs., 11 oz.
Tube Length:	45.5"
Tube Outer Diameter:	10"

ES-ON25447 - 10" Classic Dobsonian

Focal Length:	1200mm
Aperture:	254mm
Focal Ratio:	f/4.7
Focuser:	2" Crayford, with 1.25" adapter
Optical Tube Material:	Rolled steel
Mirror Figure:	Paraboloid
Mirror Coatings:	90% reflectivity, with SiO ₂ overcoat
Minor Axis of Secondary Mirror:	64mm
Eyepiece:	1.25" 25mm Plossl
Magnification with Supplied Eyepiece:	48x
Finderscope:	Red Dot
Base Handle:	Yes
Eyepiece Height at Zenith:	48"
Optical Tube Weight:	24 lbs., 3 oz.
Base Weight:	21 lbs., 8 oz.
Tube Length:	46.75"
Tube Outer Diameter:	11.9"



© Explore Scientific, LLC. 1010 South 48th Street, Springdale AR 72762.

Website: www.explorescientific.com | Toll Free: 866.252.3811 | All rights reserved. Made in China.

Contents, colors and specifications may vary.

V2025.1